

Article number: 3901044010700

Description: Worm gear with solid input shaft
VF 44P-10-HS

Measures

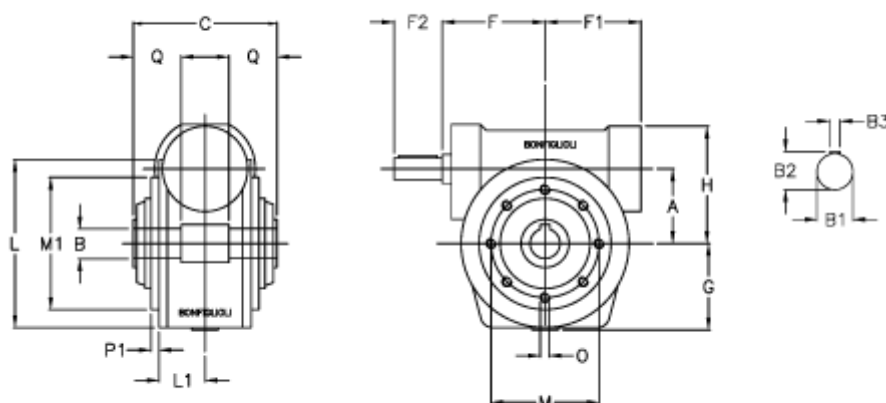

a	= 44.6	F1 = 54	O = M6x8
B	= 18	F2 = 30	P1 = 2.0
B1	= 11	g = 51	Q = 24.5
B2	= 12.5	H = 71	
B3	= 4	L = 80.0	
C	= 64	L1 = 35.0	
Description	= VF 44P-xx-HS	m = 65	
F	= 54.0	M1 = 50	